

Collezione Tom



Caratteristiche Tecniche:

Struttura: Pannello di particelle di legno.

Spessore: 60 mm.

Reti: Rete strutturale in metallo con doghe di legno.

Imbottitura: Rivestimento sfoderabile in cotone / misto lino / ciniglia / similpelle

Disponibili nella versione libera, con rete estraibile, coppia di cassettoni.

I letti e i cassettoni estraibili sono posizionabili con apertura a Dx o Sx



Richiedi il nostro configuratore per Sketchup (vers. 17 e successive)

dearkids[®]

Collezione Navy

Testata disponibile anche imbottita

Versione con piedi

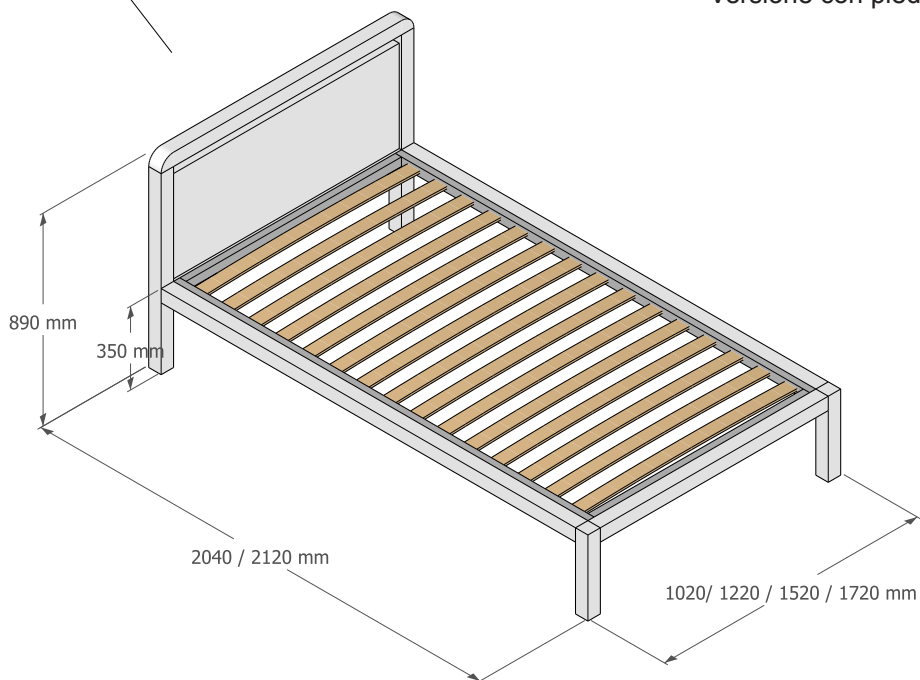

Versione con pediera

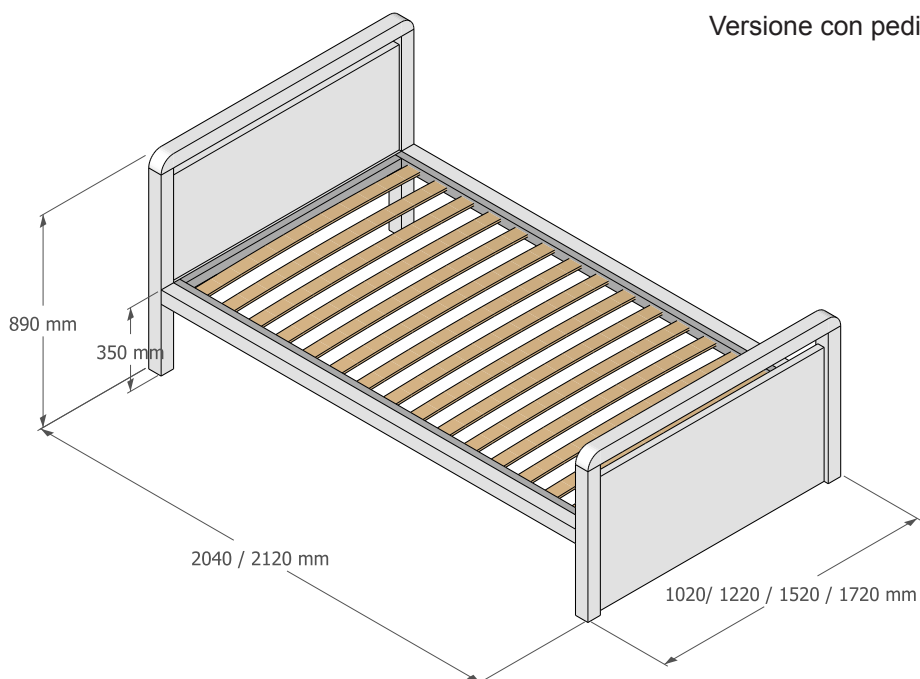

Versione con letto 2° letto estraibile o cassettoni

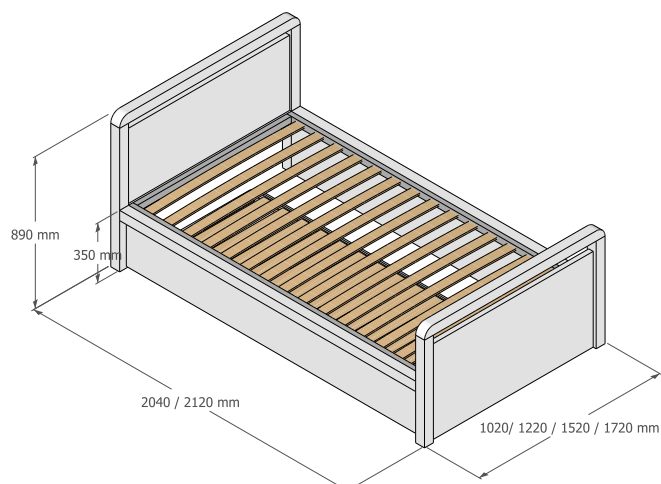
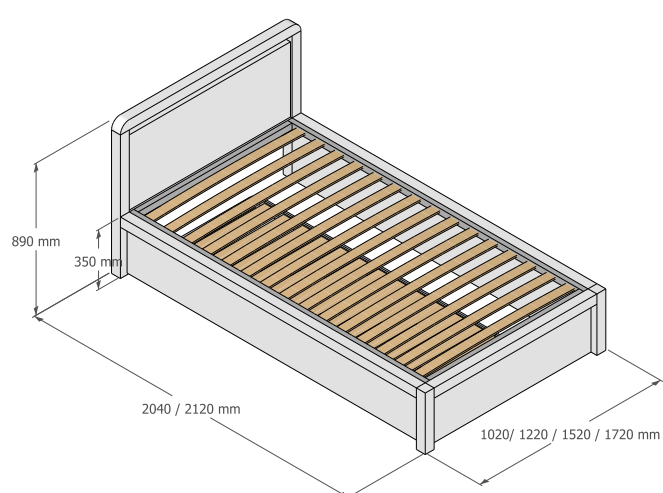

Materiali e finiture per strutture e pannelli _ Essenze



Rovere Chiaro



Rovere Moro

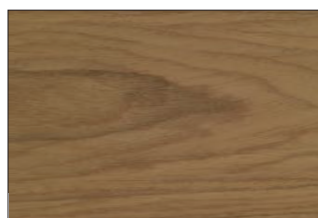

Noce Canaletto

*Le immagini sono puramente indicative, per una scelta definitiva fare riferimento ai campionari.

Materiali e finiture per strutture e pannelli _ LACCATI*

Laccatura antigraffio, a richiesta disponibile anche opaca.

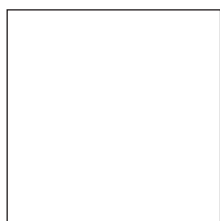

05_Bianco

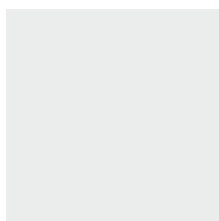

06_Ghiaccio

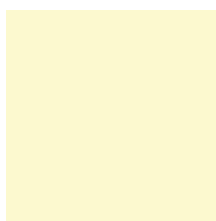

10_Crema



12_Sabbia



40_Cipria



34_Pesca



52_Rosa



55_Lilla



58_Fucsia



28_Senape



75_Pistacchio



20_Giallo Polenta



25_Zafferano



18_Limone



68_Oliva



91_Acqua marina



89_Petrolio



65_Verde Cedro



70_Verde Avocado



44_Corallo



32_Mandarino



30_Arancio



50_Rosso Cento



72_Menta



93_Londra



90_Cielo



98_Turchese



92_Celeste



94_Polvere

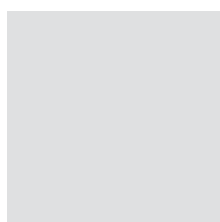

08_Nebbia

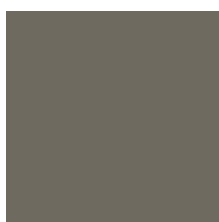

100_Grigio



99_Antracite



88_Muschio

Tessuti categoria "A"



720_Var. 11



720_Var. 16



720_Var. 33



720_Var. 41



720_Var. 43



720_Var. 44

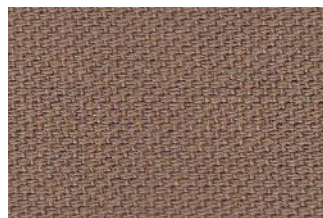

720_Var. 47



8023_Var. 2



8023_Var. 12



8023_Var. 13



8023_Var. 14



8023_Var. 22



8047_Var. 4



8047_Var. 8



8047_Var. 10

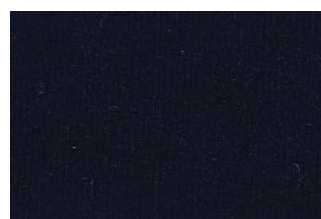

8047_Var. 14



8047_Var. 15



8047_Var. 17

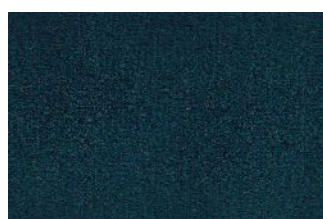

8047_Var. 19

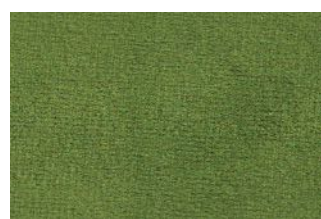

8047_Var. 21



8047_Var. 24



TAMINO_Var. 8



TAMINO_Var. 14



TAMINO_Var. 15



TAMINO_Var. 17



TAMINO_Var. 22

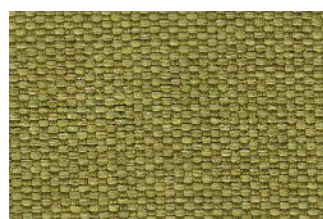

TAMINO_Var. 24



TAMINO_Var. 612

Tessuti categoria "A"



TAMINO_Var. 617

Similpelle categoria "A"

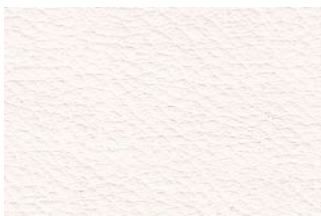

4026 Var. 1



4026 Var. 4



4026 Var. 6



4026 Var. 26

Tessuti categoria "B"



1407_Var. 64 - Riso

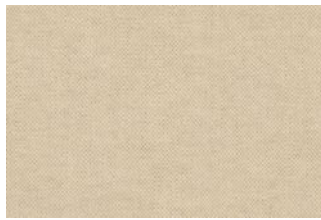

1407_Var. 11 - Tela



1407_Var. 42 - Silver



1407_Var. 26 - Senape



1407_Var. 25 - Grano



1407_Var. 19 - Melrose



1407_Var. 68 - Peonia



1407_Var. 30 - Prato



1407_Var. 33 - India



1407_Var. 50 - Orange



1407_Var. 18 - Cherry



1407_Var. 54 - Londra



1407_Var. 76 - Lagoon



1407_Var. 77 - Sugar



1407_Var. 06 - Santorini



1407_Var. 58 - Stone

Tessuti categoria "C"

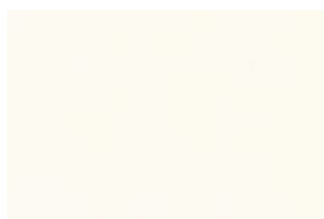

V3078_Var. 86 Tusk



V3078_Var. 69 Dew



V3078_Var. 80 Fjord

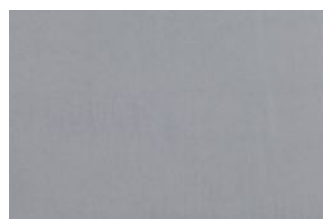

V3078_Var. 13 Steel



V3078_Var. 54 Fondant

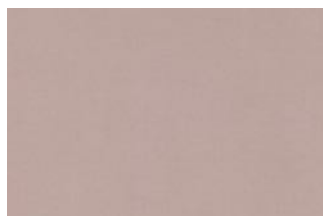

V3078_Var. 55 Blossom

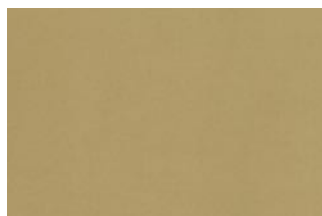

V3078_Var. 51 Gold

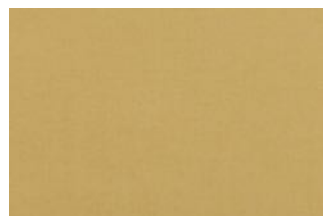

V3078_Var. 04 Acacia



V3078_Var. 83 Willow

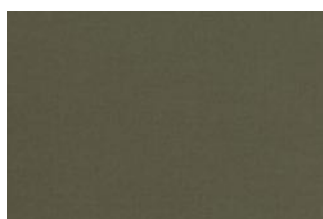

V3078_Var. 82 Kombu



V3078_Var. 75 Teal



V3078_Var. 76 Ocean

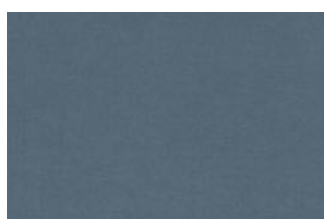

V3078_Var. 79 Pacific

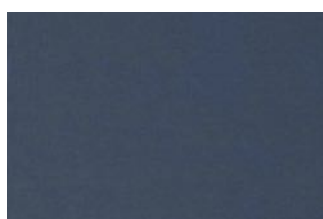

V3078_Var. 90 Smoky



V3078_Var. 06 Navy

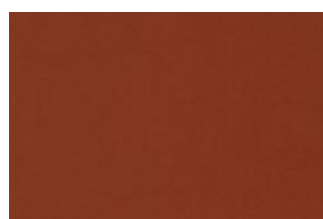

V3078_Var. 59 Flame

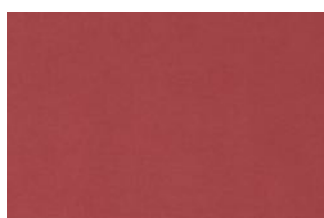

V3078_Var. 61 Raspberry

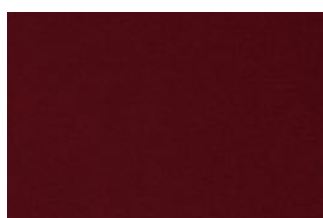

V3078_Var. 92 Redcurrant

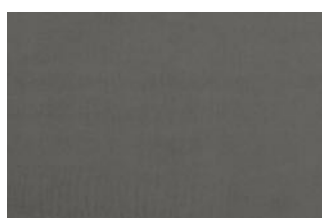

V3078_Var. 18 Mole



V3078_Var. 15 Tornado

Istruzioni di lavaggio

Tessuto Art. 720

Composizione:
100% cotone Sanforizzato.

Manutenzione:



Tessuto Art. 8023

Tessuto Antimacchia

Composizione:
100% Poliestere

Manutenzione:



Tessuto Art. 8047

Tessuto Antimacchia

Composizione:
100% Poliestere

Manutenzione:



Tessuto Art. Tamino

Tessuto Antimacchia

Composizione:
100% Poliestere

Manutenzione:



Tessuto Art. 4026

Composizione:
85% PVC 15% Poliestere

Manutenzione:



Tessuto Art. 1407

Composizione:
Misto lino

Manutenzione:



Tessuto Art. V3078

Composizione:
100% Ciniglia Easy Clean

Manutenzione:



Tessuto Art. 5000

Composizione:
85% Poliestere 15% Lino

Manutenzione:



Simbologie



Stirare con ferro tiepido (110°)



Stirare con ferro poco caldo (150°)



Lavatrice MAX 30°



Lavare a mano



Lavare a secco



Non candeggiare



Non asciugare in tamburo con aria calda